

BenQ
DV3750
LCD Display
User's Manual

Welcome

i Copyright

Copyright BenQ Corporation. All rights reserved. No part of this User's Manual may be reproduced, transmitted, transcribed, stored in a retrieval system or translated into any language or computer language, in any form or by any means, electronic, mechanical, magnetic, optical, chemical, manual or otherwise, without the prior written permission of BenQ Corporation.



Dolby, Pro Logic, and the double-D symbol are registered trademarks of Dolby Laboratories. Manufactured under license from Dolby Laboratories.



is a trademark of SRS Labs, Inc. TruSurround XT technology is incorporated under license from SRS Labs, Inc.

All other trademarks or product names used in this document are the registered property of their respective owners.

ii Disclaimer

BenQ Corporation makes no representations or warranties, either expressed or implied, with respect to the contents of this User's Manual. BenQ Corporation reserves the right to revise this publication and to make changes from time to time in the contents thereof without obligation to notify any person of such revision or changes.

Unit is for entertainment use only and Visual Display tasks are excluded.

iii Important Safety Instructions

Electrical energy can perform many useful functions, but it can also cause personal injury and property damage if improperly handled. This product has been engineered and manufactured with the highest priority on safety, however **IMPROPER USE CAN RESULT IN POTENTIAL ELECTRICAL SHOCK OR FIRE HAZARD**. In order to prevent potential danger, please observe the following instructions when installing, operating and cleaning the product. Proper care will also prolong the service life of your BenQ display. Just follow these simple instructions before using your display

1. **Read instructions** - All operating instructions must be read and understood before the product is operated.
2. **Retain instructions** - These safety and operating instructions must be kept in a safe place for future reference.
3. **Observe warnings** - All warnings on the product and in the instructions must be observed closely.
4. **Follow instructions** - All operating instructions must be followed.
5. **Water and moisture** - Do not use this product near water - for example, near a bathtub, washbowl, kitchen sink, or laundry tub, in a wet basement, or near a swimming pool, and the like. Do not use immediately after moving from a low temperature to a high temperature environment, as this causes condensation, which may result in fire, electric shock, or other hazards.
6. **Cleaning** - Unplug this product from the wall outlet before cleaning. Do not use liquid cleaners or aerosol cleaners. Use a damp cloth for cleaning.

Periodically clean the liquid crystal panel of the display to ensure a clear screen and prolong the service life of the panel. Use a clean, soft and cotton-free dry cloth to dip into the specific cleaner for the liquid crystal panel. Quickly wipe over the whole panel and use another cloth to clean the panel.

7. **Ventilation** - The vents and other openings in the cabinet are designed to let hot air escape from the display. Do not cover or block these vents and openings since insufficient ventilation can cause overheating and/or shorten the life of the product. Do not place the display on a bed, sofa, rug or other similar surface, since they can block ventilation openings. This display is not designed for built-in installation; do not place the product in an enclosed place such as a bookcase or rack, unless proper ventilation is provided or the manufacturer's instructions are followed.
8. **Heat sources** - Keep the product away from heat sources such as radiators, heaters, stoves and other heat-generating products (including amplifiers).
9. **Power cord protection** - Power-supply cords should be routed so that they are not likely to be walked on or bitten by small animals. Pay particular attention to cords at doors, plugs, receptacles, and the point where they exit from the product.
10. **Attachments** - Do not use attachments not recommended by the manufacturer. Use of improper attachments can result in accidents.
11. **Accessories** - When the product is used on a trolley, care should be taken to avoid quick stops, excessive force, and uneven surfaces that may cause the product and trolley to overturn, damaging equipment or causing possible injury to the operator. Do not place this product on an unstable trolley, stand, pedestal, bracket, or table. The product may fall, causing serious injury to a child or adult and serious damage to the product. The product should be mounted according to the manufacturer's instructions, and use only with a trolley, stand, pedestal, bracket, or table recommended by the manufacturer.
12. **Servicing** - Do not attempt to service the product yourself. Removing covers can expose you to high voltage and other dangerous conditions. Request a qualified service person to perform servicing.
13. **Replacement parts** - In case the product needs replacement parts, make sure that the service person uses replacement parts specified by the manufacturer, or those with the same characteristics and performance as the original parts. Use of unauthorized parts can result in fire, electric shock and/or other danger.
14. **Overloading** - Do not overload wall outlets, extension cords, or convenience receptacles on other equipment as this can result in a risk of fire or electric shock.
15. **Entering of objects and liquids** - Never poke an object into the product through vents or openings. High voltage flows in the product, and inserting an object can cause electric shock and/or short circuit internal parts. For the same reason, do not spill water or liquid on the product.
16. **Damage requiring service** - If any of the following conditions occurs, unplug the power cord from the AC outlet, and request a qualified service person to perform repairs.
 - When the power cord or plug is damaged.
 - When a liquid is spilled on the product or when objects have fallen into the product.
 - When the product has been exposed to rain or water.
 - When the product does not operate properly as described in the operating instructions.
 - Do not touch the controls other than those described in the operating instructions. Improper adjustment of controls not described in the instructions can cause damage, which often requires extensive adjustment work by a qualified technician.
 - If the product has been dropped or the cabinet has been damaged in any way.
 - When the product displays an abnormal condition or exhibits a distinct change in performance. Any noticeable abnormality in the product indicates that the product needs servicing.
17. **Safety checks** - Upon completion of service or repair work, request the service technician to perform safety checks to ensure that the product is in proper operating condition.
18. **Wall mounting** - When mounting the product on a wall, be sure to install the product according to the method recommended by the manufacturer using only the manufacturers mounting hardware.

- 19. **Stand** - Do not place the product on an unstable trolley, stand, tripod or table. Placing the product on an unstable base can cause the product to fall, resulting in serious personal injuries as well as damage to the product.
- 20. **Careful move** - When relocating the product placed on a trolley, it must be moved with the utmost care. Sudden stops, excessive force and uneven floor surfaces can cause the product to fall from the trolley.
- 21. **Panel protection** - The LCD panel used in this product is made of glass. Therefore, it can break when the display is dropped or hit by other objects. Beware of injuries in the event of the LCD glass screen breaking.
- 22. **Pixel defect** - The LCD panel is a high technology product, giving you finely detailed pictures. Occasionally, a few non-active pixels may appear on the screen as a fixed point of blue, green or red. Please note that this does not affect the performance of your product.
- 23. **Installation of an external antenna** - If an outside antenna is connected to the television equipment, be sure the antenna system is grounded so as to provide some protection against voltage surges and built-up static charges.



For added protection for this television equipment during a lightning storm, or when it is left unattended and unused for long periods of time, unplug it from the wall outlet and disconnect the antenna. This will prevent damage to the equipment due to lightning and power-line surges.

An outside antenna system should not be located in the vicinity of overhead power lines or other electric light or power circuits, or where it can collide with such power lines or circuits. When installing an outside antenna system, extreme care should be taken to keep from touching such power lines or circuits, as contact with them might be fatal..

Important Information

WARNING: TO REDUCE THE RISK OF FIRE OR ELECTRIC SHOCK, DONOT EXPOSE THIS PRODUCT TO RAIN OR MOISTURE.

CAUTION: TO PREVENT ELECTRIC SHOCK, MATCH WIDE BLADE OF PLUG TO WIDE SLOT, FULLY INSERT.

	<p>CAUTION RISK OF ELECTRIC SHOCK DO NOT OPEN</p>	
<p>CAUTION: TO REDUCE THE RISK OF ELECTRIC SHOCK, DO NOT REMOVE COVER (OR BACK). NO USER-SERVICEABLE PARTS INSIDE. REFER SERVICING TO QUALIFIED SERVICE PERSONNEL.</p>		

The exclamation point within a triangle is intended to alert the user to the presence of important operating and maintenance (servicing) instructions in the literature accompanying the product



The lightning flash with arrowhead symbol within a triangle, alerts the user to the presence of uninsulated "dangerous voltage" within the product's enclosure that may constitute a risk of electric shock.



iv Table of Contents

Introduction.....	1
Functions and Features	1
Package Contents.....	2
Getting Started with Your Display.....	3
Main Unit (Front View)	3
Control Panel	3
Terminal Panel.....	4
Main Unit (Rear View).....	5
Setting up Your Display	6
Connecting the Antenna	6
Connecting Audio and Video Signal Sources	6
Connecting Composite (AV) Video Signal (RCA).....	7
Connecting Composite (AV) Video Signal (SCART)	7
Connecting S-Video Signals.....	8
Connecting Component Video Signals.....	8
Connecting RGB Signals (Mini D-SUB).....	9
Connecting DVI Signals.....	9
Connecting Audio Output Signals	10
Connecting the Power Cord	10
Initial Setup	11
Remote Control	12
Using the Remote Control	14
Batteries.....	14
Notes on Using Batteries	14
Using the Remote Control	15
Power on, Power off and Standby	15
Turning on the display.....	15
Turning off the display.....	15
Switching Inputs	15
Adjusting Volume.....	15
Adjusting the volume	15
Mute setting.....	15
TV sound mode selection	15
Changing Channels.....	15
Change Channels Using the Channel selection buttons	15
Using the Channel ▲ / ▼ buttons to sequentially change channels.....	16
Using the channel return button to return to the previous viewed channel.....	16

Selecting a Picture Mode	16
Using the Freeze Function.....	16
Adjusting Aspect Ratio	16
Using the Picture-in-Picture (PIP)/Picture-by-Picture (PBP) Function	16
Using the Sleep Timer	17
Adjusting Backlight.....	17
Display Information	17
Using the Teletext Function.....	17
On-Screen Display (OSD) Menu	18
OSD Structure.....	18
Navigating the OSD Menu	19
Audio Menu	19
Picture Menu.....	21
Picture Mode Settings.....	22
Selecting a Picture Mode	22
Feature Menu	23
TV Menu	25
Performing Manual Installation	26
Editing Channels.....	26
Naming a Channel	26
Swapping Channels	27
Locking (Preventing a Channel from Selection)/Unlocking a Channel	27
Deleting a Channel	27
Child Lock.....	27
Enabling/Disabling Child Lock	27
Changing Password	28
PC Menu	28
Troubleshooting.....	29
TV	29
Antenna	30
Specifications	31
Supported Modes	32
Dimensional Drawings.....	32

1 Introduction

Thank you for purchasing the BenQ DV3750 LCD Display. Your DV3750 will bring you years of high-quality viewing enjoyment. It is also extremely easy to operate, and provides exceptionally high image quality.

The DV3750 is also extremely versatile. You can install it on the wall (optional wall-mounting kit is required) or set it on a table, and it can be used under any type of illumination.

This manual will explain the operation of the DV3750, including its functions and features and other important information. Before installing or operating your liquid crystal display, please take the time to thoroughly read this manual, particularly the sections on safety.

Functions and Features

The DV3750 has many useful functions and features, including:

- 1920 x 1080 image resolution
- 550 nits brightness
- 800:1 contrast ratio
- Compatible with all digital television (DTV) formats, including 1080i, 720P, 576P and 480P
- 2:2 Pull Down Recovery
- De-Interlacing
- Multiple picture modes
- Picture In Picture and Picture By Picture display functions
- Virtual Dolby Surround Pro Logic II surround experience
- SRS TruSurround XT surround experience
- Graphic OSD
- Shortcut buttons:
 1. Freeze frame
 2. Stereo/MTS television sound
 3. Sleep timer
 4. Back light adjustment
 5. PC/DVI input signal auto calibration
 6. Aspect ratio adjustment
 7. Teletext

2 Package Contents

Please ensure that the following items are included with your DV3750 LCD Display. If any item is missing or damaged, contact an authorized dealer immediately.



DV3750 LCD Display (x1)

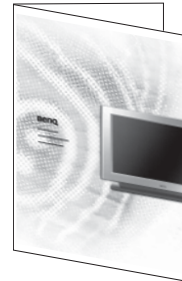

User's manual (x1)



Power cord (x1)



Composite (AV) video cable (x1)



Remote control (x1)

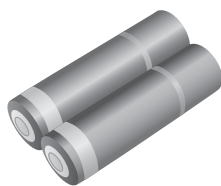

AAA batteries (x2)

 **Actual number and type of cables may vary with the location of purchase.**

3 Getting Started with Your Display

Main Unit (Front View)



No.	Name	Description
1	Power indicator	<ul style="list-style-type: none"> Lights up green when the display is powered on. Lights up red when the display is in standby mode. Flashes red when the display is connected to a PC and the PC enters standby mode.
2	Remote control sensor window	Receives the signal from the remote control. Do not put any objects in front of the window in order not to hinder the reception of signals.

Control Panel

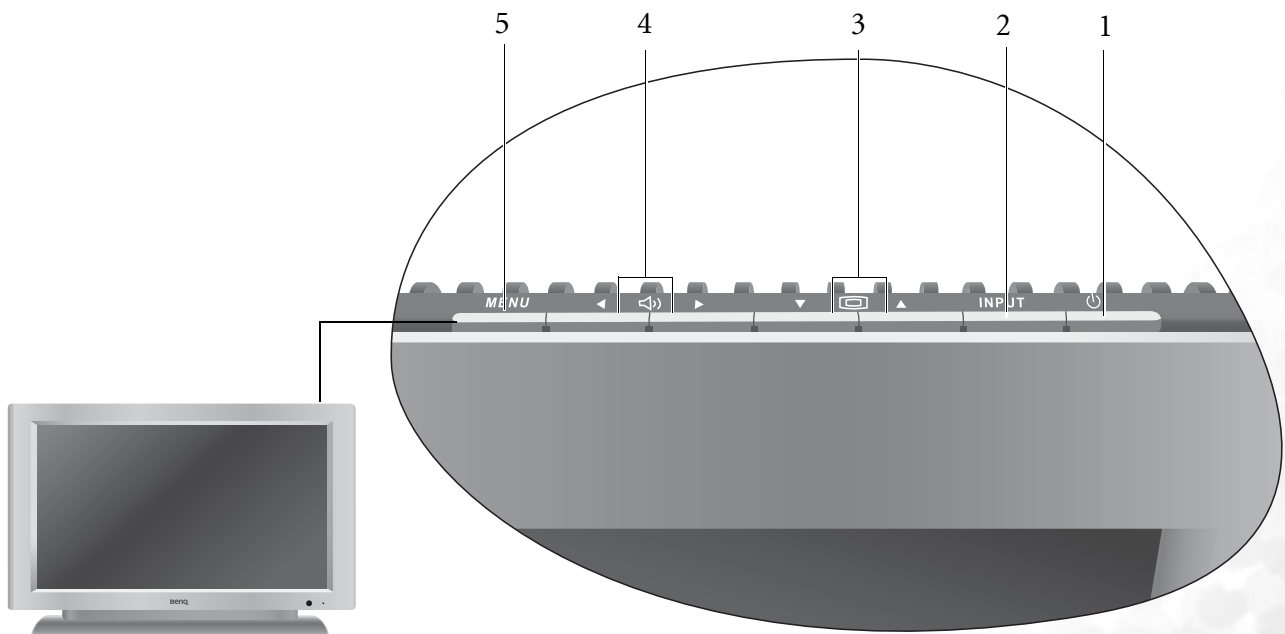

No.	Name	Description
1	Power	<ul style="list-style-type: none"> Press this button to turn the display on when it is in standby mode. Press this button once more to turn the display off by placing it into standby mode.

2	INPUT	<ul style="list-style-type: none"> • This button allows you to switch among signal sources. • When the OSD (On-Screen Display) menu is on, press this button to enter the submenu.
3	Channel ▼ / ▲ button	<ul style="list-style-type: none"> • Press these buttons to sequentially select channels. • When the OSD menu is on, press these buttons to move the selection focus up or down or change settings.
4	Volume ◀ / ▶ button	<ul style="list-style-type: none"> • Press Volume ▶ to increase the volume, or Volume ◀ to decrease it. • When the OSD menu is on, press these buttons to move the selection focus left and right or change settings.
5	MENU button	<ul style="list-style-type: none"> • Press this button to display the OSD menu. • When the OSD menu is on, press this button to exit the menu.

Terminal Panel

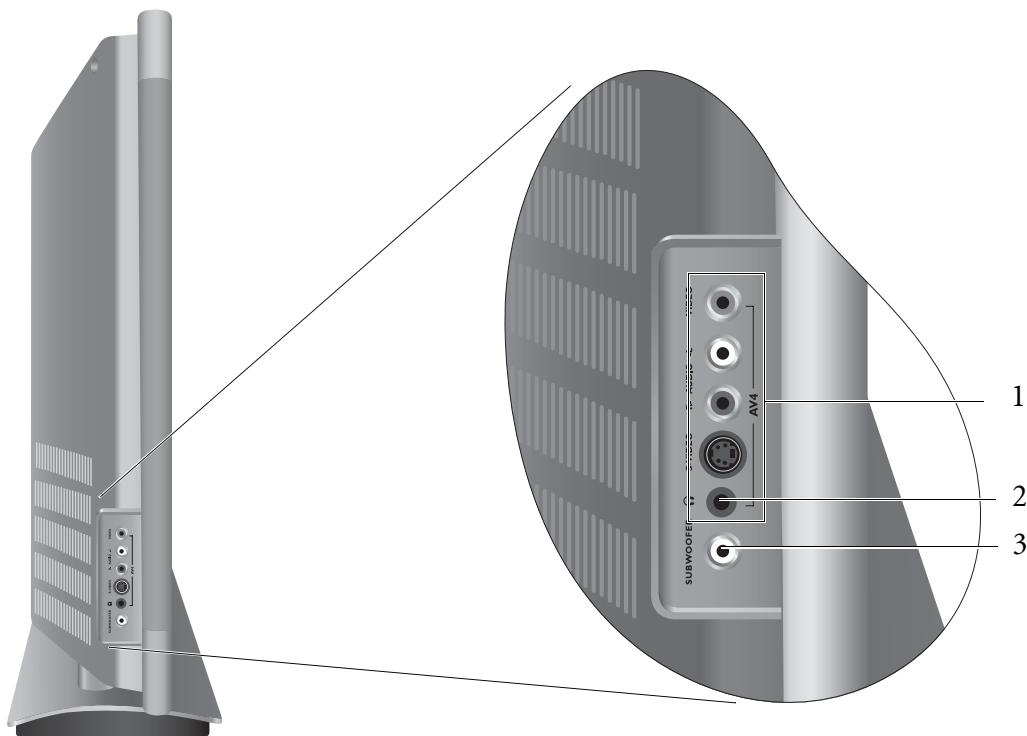

No.	Name	Description
1	AV4	<ul style="list-style-type: none"> • VIDEO (Composite (AV) signal input, RCA connector): Connect the Composite video output of your AV device here. • AUDIO(Audio input, L/R): Connect the audio output of your AV device here. This input is used common to both AV and S-VIDEO input. • S-VIDEO (S-VIDEO input): Connect the S-VIDEO output of your AV device here.
2	Headset socket	This socket is for connecting an external headset.
3	Subwoofer	Allows you to connect the display to an external subwoofer set for outputting sound.

Main Unit (Rear View)

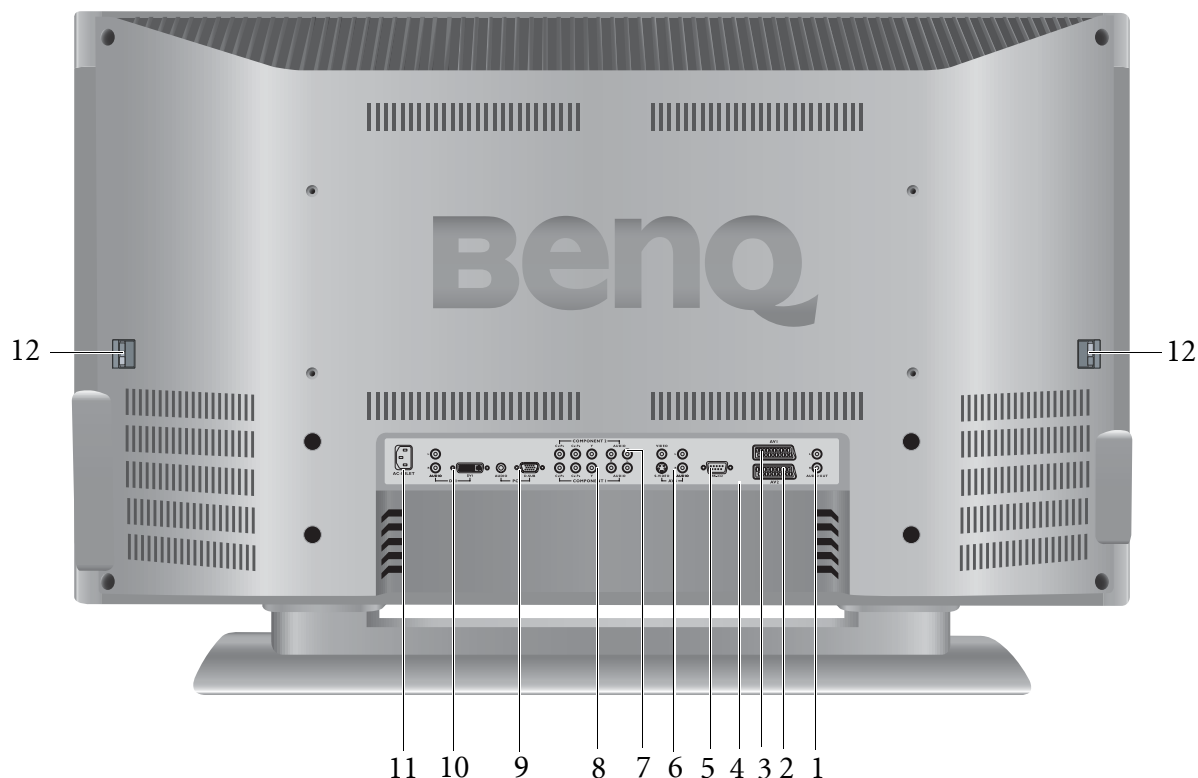

No.	Name	Description
1	AUDIO OUT (L/R)	Connect the audio input of an amplifier here.
2	AV2 (SCART connector)	Allows you to connect to the SCART output terminal of your DVD player or other AV devices.
3	AV1 (SCART connector)	Allows you to connect to the SCART output terminal of your DVD player or other AV devices.
4	TV/CATV Antenna	Connect your antenna to this input.
5	RS232	This terminal is for service purpose only.
6	AV3 (RCA connector)	<ul style="list-style-type: none"> • VIDEO (Composite (AV) signal input, RCA connector): Connect the Composite video output of your AV device here. • AUDIO (Audio input, L/R): Connect the audio output of your AV device here. This input is used common to both AV and S-VIDEO input. • S-VIDEO (S-VIDEO input): Connect the S-VIDEO output of your AV device here.
7	COMPONENT 2	<ul style="list-style-type: none"> • Y C_B/P_B C_R/P_R (Y C_B/P_B C_R/P_R input): Connect the component image output of your AV devices or HDTV decoder here. The Y (green) connector can also be used as a second composite signal input. • AUDIO (Audio input, L/R): Connect the audio output of your AV device here.
8	COMPONENT 1	<ul style="list-style-type: none"> • Y C_B/P_B C_R/P_R (Y C_B/P_B C_R/P_R input): Connect the component image output of your AV devices or HDTV decoder here. The Y (green) connector can also be used as a second composite signal input. • AUDIO (Audio input, L/R): Connect the audio output of your AV device here.

9	PC	<ul style="list-style-type: none"> • PC D-SUB (15-pin D-SUB computer signal input): For connecting to PC's analog video output. • PC AUDIO: For connecting to PC's audio output.
10	DVI (Digital Video Interface)	<ul style="list-style-type: none"> • DVI (Digital Video Interface): For connecting to PC's digital video output. • DVI AUDIO (Audio input, L/R): For connecting to DVI's digital audio output.
11	AC INLET	Connect the power cord to this input.
12	Speaker connectors	Connect the external speakers to these connectors.

4 Setting up Your Display

Connecting the Antenna

The antenna equipment has far more effect on reception for color TVs than on black and white models. For best reception it is recommended that an outdoor antenna be used. Connect the lead from the outdoor antenna to the antenna input on the rear of the display.

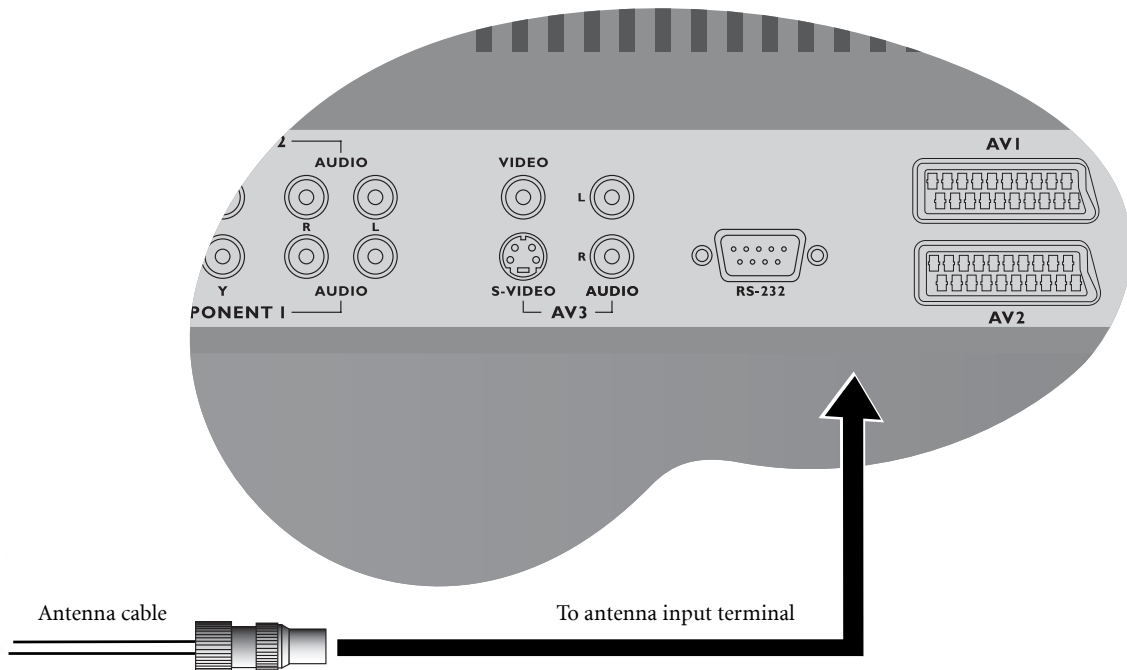

Connecting Audio and Video Signal Sources

- Before connecting any component, please familiarise yourself with the location and type of each input.
- If incorrect connections are made, picture or colour quality may be adversely affected. Please ensure that all connectors are firmly seated.
- Before connecting, turn off the power to the external devices for safety.

Connecting Composite (AV) Video Signal (RCA)

Connect the Composite (AV) output of your AV equipment to the Composite (AV3) signal terminal on the display using a Composite (AV) video cable (RCA connector) as illustrated.

☞ Composite video input is the most commonly used signal input. However, this type of input also provides a less optimal image quality. Many video sources can only output Composite video signals, for example, VCRs and camcorders. Other video sources, such as laser disc players, actually produce slightly better results when using Composite video.

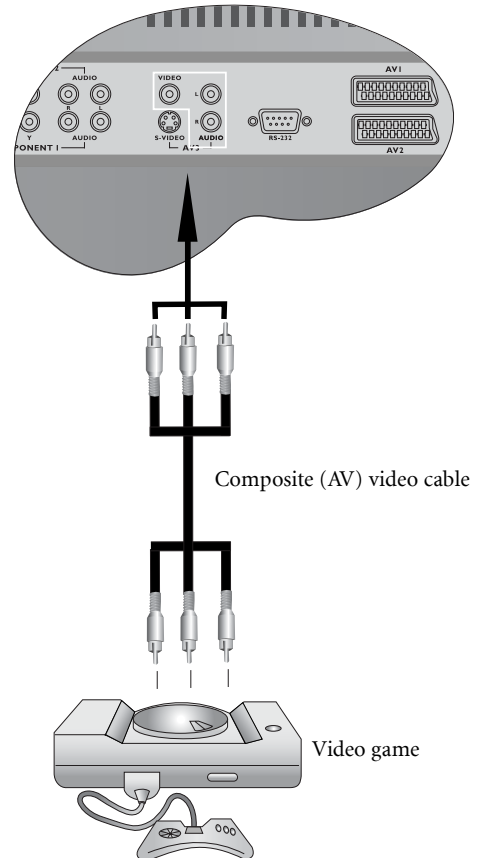

Connecting Composite (AV) Video Signal (SCART)

Connect the AV1 or AV2 (SCART) input terminal on the TV to the SCART terminal on the AV equipment using a SCART cable.

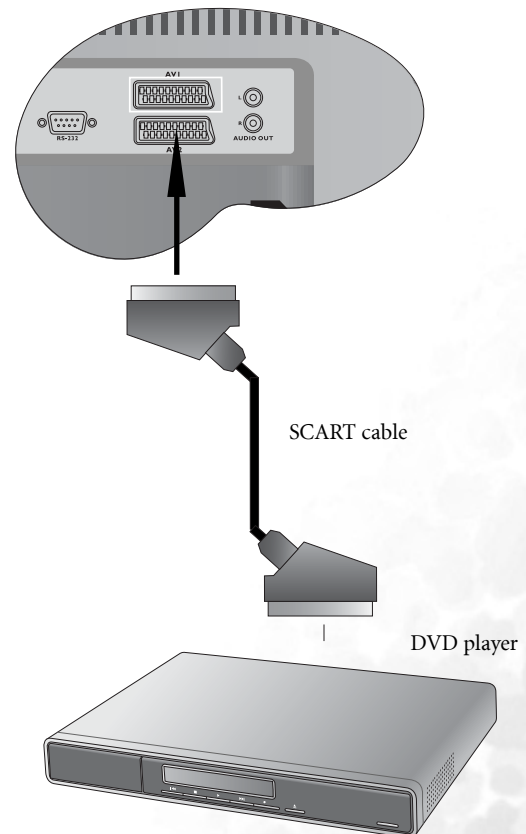

Connecting S-Video Signals

1. Connect the S-Video output of your AV equipment to the display's S-VIDEO terminal using an S-Video cable. Pay attention to the direction of the connector on the S-Video cable when inserting.
2. Connect the audio output of your AV equipment to the display's S-VIDEO AUDIO L/R input terminals using the AV cable or equivalent.

☞ An S-video signal provides a higher quality image to that of Composite video. It is recommended to use this input whenever possible. If your AV equipment provides a component video output (YPbPr or YCbCr), this should be used in preference to either composite or S-video signals.

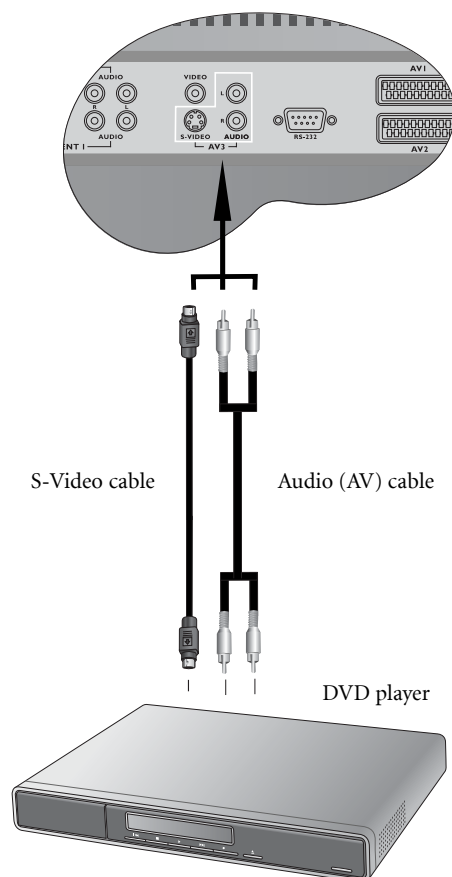

Connecting Component Video Signals

1. Connect the Component video output of your AV equipment to the display's COMPONENT Y CB/PB CR/PR terminals using a Component video cable.
2. Connect the audio output of your AV equipment to the display's COMPONENT AUDIO L/R input terminals using the AV cable or equivalent.

- ☞ 1. Of the currently available video signal types, Component video input offers the best quality. Component video output is available on progressive scan DVD players and Digital television decoders. The image quality with this type of input is superior to that obtained with S-video. All High Definition Television signals must go through this input.**
2. DV3750 supports 480P, 720P, 576P and 1080i HDTV signals provided by high definition AV equipment such as a HDTV decoder.
 3. Ensure the connector colors match, failure to connect the colors of the cables to the corresponding colored terminals will result in an incorrectly colour image or badly distorted image.

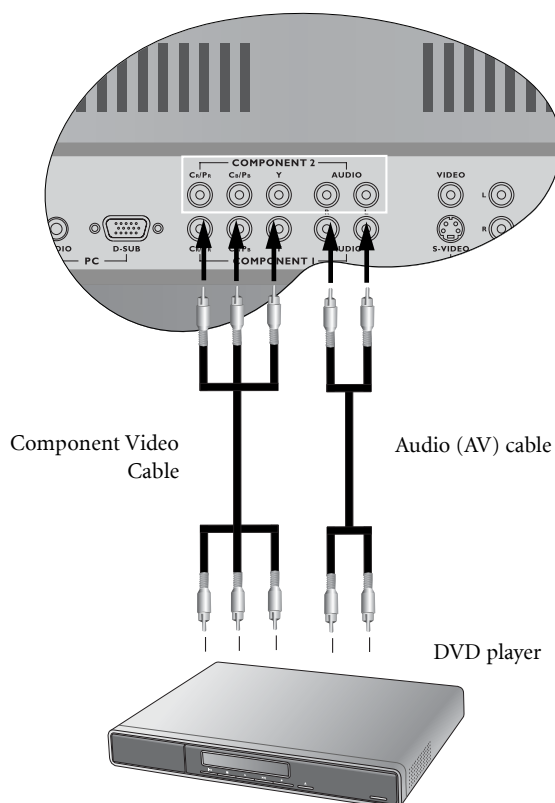

Connecting RGB Signals (Mini D-SUB)

1. Connect the analog video output of your PC to the PC D-SUB terminal on the display using a Mini D-SUB 15-pin cable.
 2. Connect the audio output of your PC to the display's PC AUDIO input terminal using an appropriate cable.
- ☞
1. If the signal resolution is greater than the default resolution, the screen may be unable to display image details clearly.
 2. You will need a converter to connect a Macintosh computer video to the display using a PC D-SUB 15-pin cable.
 3. Certain PC models cannot be connected to the display.
 4. The computer in the illustration is shown only for reference; your equipment may vary.
 5. Additional equipment shown in the illustration is not provided.
 6. Do not set the computer's horizontal and vertical scanning frequencies less than or greater than the frequency range of the display. (refer to "Supported Modes" on page 32)
 7. If you require more information on how to connect your equipment, please refer to the manual for the piece of equipment you wish to attach.

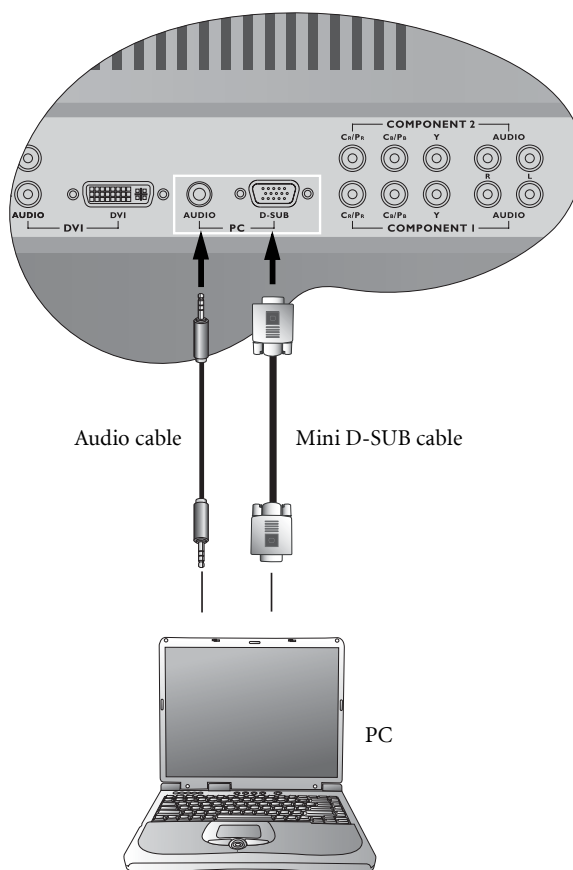

Connecting DVI Signals

1. Connect the digital video output of your PC to the DVI terminal on the display using a DVI-D cable.
2. Connect the audio output of your PC to the display's DVI AUDIO L/R input terminals using the AV cable or equivalent.

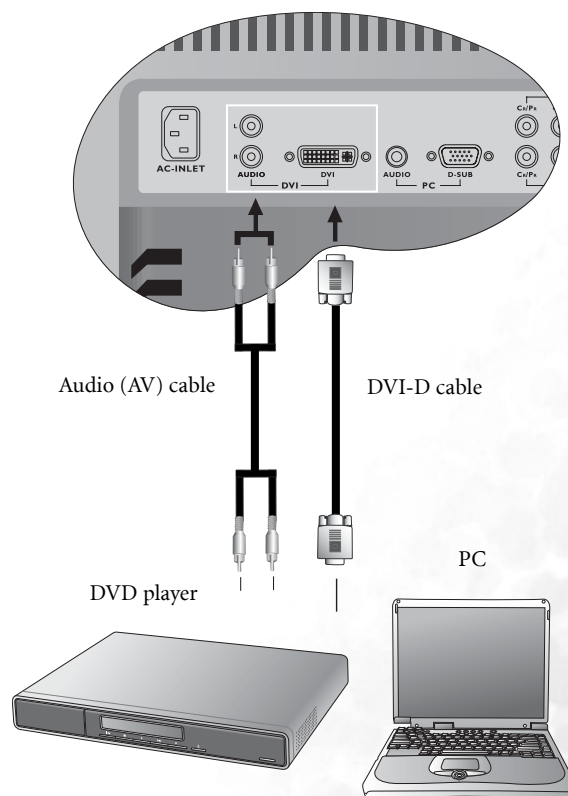

Connecting Audio Output Signals

DV3750 provides extra audio output terminals for delivering audio signal to an amplifier or other audio devices.

Connect the AUDIO OUT L/R terminals on the display to the signal input terminals of an amplifier or other audio devices using the AV cable or equivalent.

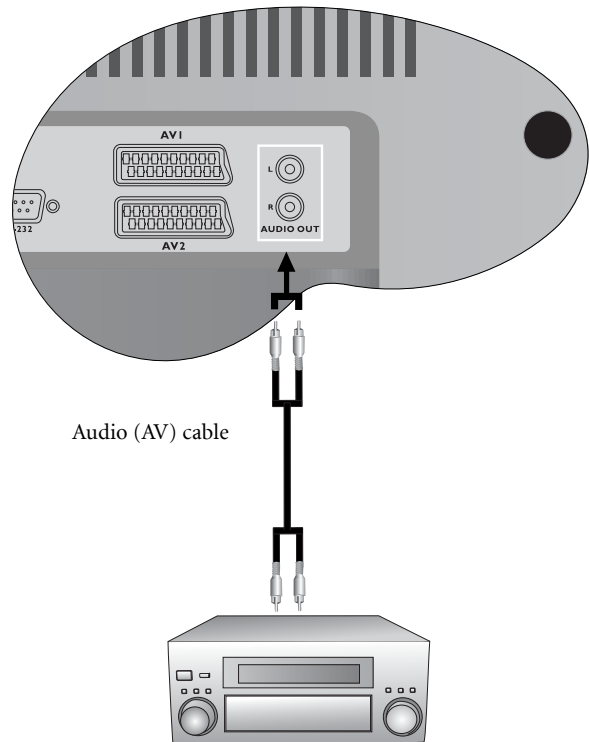

Connecting the Power Cord

1. Connect the female end of the AC power cord to the AC input on the display.
2. As shown in the diagram, connect the male end to a wall power outlet.

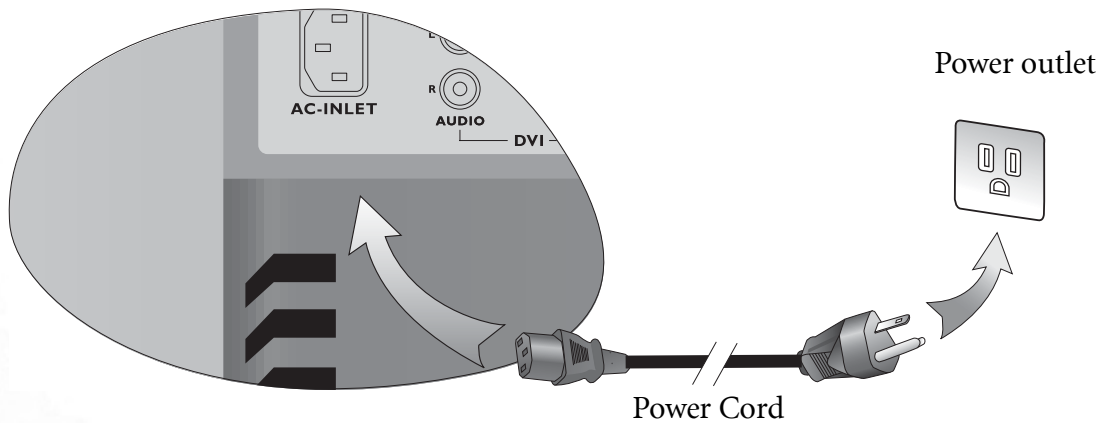

- The figure above shows the power cord connection. The shape of the physical power cord plug and socket will differ depending on the location where you purchased the display.
- This product must be operated only from the type of power source indicated on the marking label (AC 100-240V 50-60 Hz).
- If the display will not be used for a long period of time, it should be unplugged from the wall outlet.

Initial Setup

1. Check to make sure that all connections to your display are correct and firm.
2. Press the **Power** button on the display. The display will turn on. The following First Turn On screen will appear.

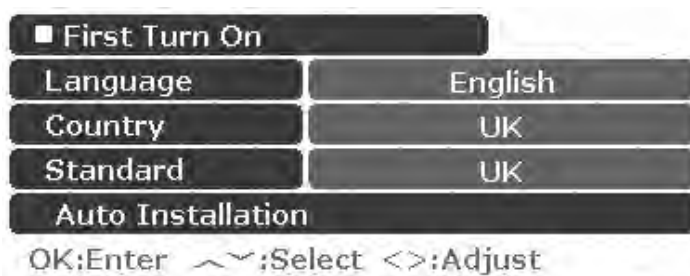

3. Press the **Volume** ◀ or **Volume** ▶ buttons on the display to select a screen display language, and then press the **Channel** ▼ button on the display to go to the next step.
4. Press the **Volume** ◀ or **Volume** ▶ buttons on the display to select your country, and then press the **Channel** ▼ button on the display to go to the next step.
5. (Optional) If **Others** is selected in **Country**, press the **Volume** ◀ or **Volume** ▶ buttons on the display to select a TV broadcast standard.
6. Press the **Channel** ▼ button on the display to select **Auto Installation** and then press the **INPUT** button. The display will start searching for available channels and store them in the memory. This may take several minutes, depending on the available TV channels of your local TV system.
7. Press the **MENU** button on the display to close the menu.

5 Remote Control

Below is the function description for each button on your remote control.

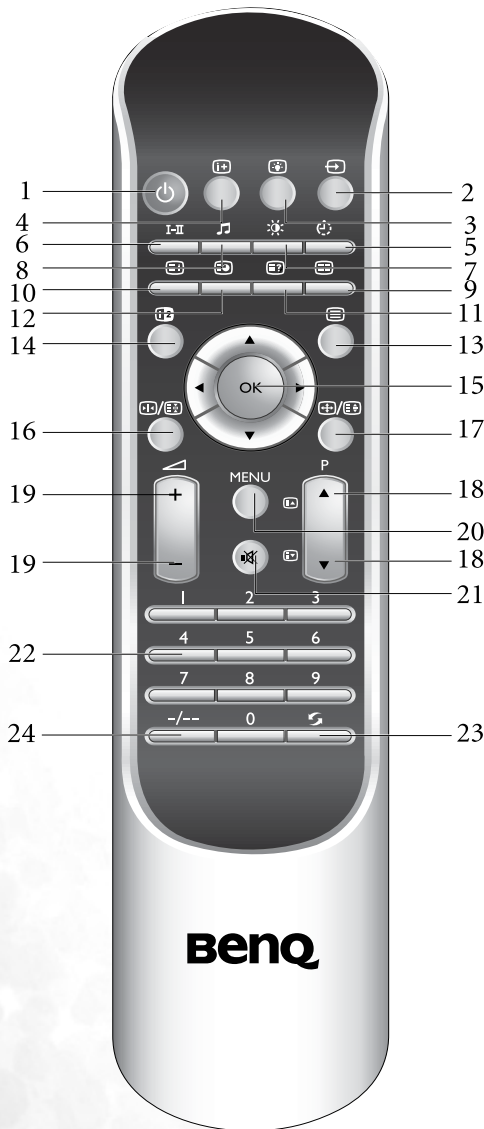

1. (Power)

Press this button to power on the display. Press again to put the display to standby mode.

2. (Input)

Press this button to select your desired input source.

3. (Backlight)

Press this button to adjust screen backlight.

4. (Information)

Press this button to display the TV channel message and other signal messages (including video or computer signals).

5. (Sleep timer/Teletext page selection)

- Press this button to set the automatic shut-off timer.
- When Teletext is displayed on the screen, press this button to switch to a specific page.

6. (TV sound/Teletext page selection)

- Press this button to toggle between stereo and mono sound reception. During dual language broadcasts Lang-1 or Lang-2 can be selected.
- When Teletext is displayed on the screen, press this button to switch to a specific page.

7. (Picture mode/Teletext page selection)

- Press this button to select from among 6 picture modes.
- When Teletext is displayed on the screen, press this button to switch to a specific page.

8. (Audio mode/Teletext page selection)

- Press this button to select between Sound 1 (left audio), Sound 2 (right audio) and Stereo. (Not available during TV reception)
- When Teletext is displayed on the screen, press this button to switch to a specific page.

9. (Teletext display)

Press this button to cycle Teletext display types between Teletext only - mixed display.

10. (Teletext index)

Press this button to go to Teletext index page.

11. (Teletext information)

Press this button to display some concealed Teletext information.

12. (Enter Teletext subpage)

Press this button to enter the subpage of a Teletext menu.

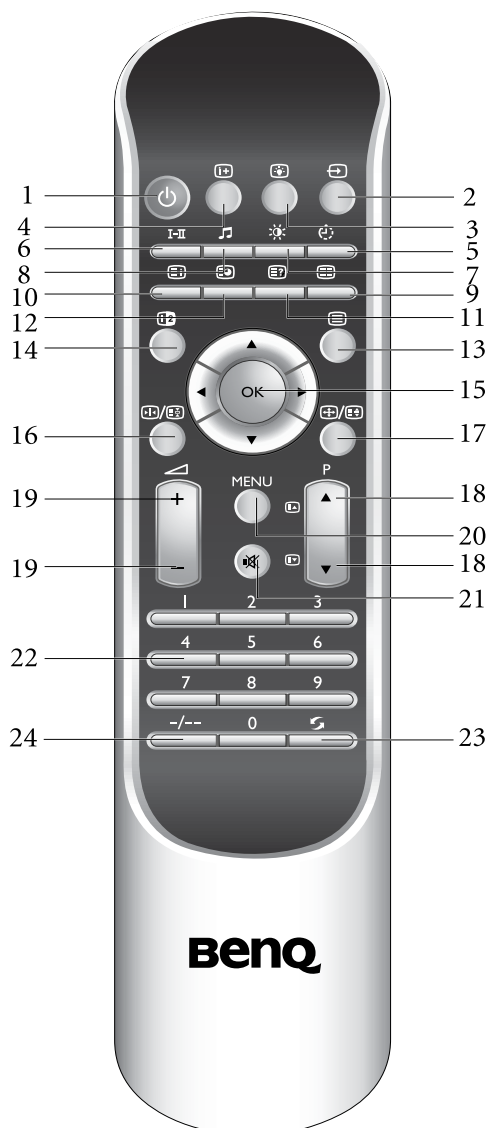









13. (Teletext)

Press this button to turn on the Teletext function, press this button again to turn it off.

14. PIP/PBP

Press this button to simultaneously view signals from two different sources on the screen. You may choose picture-in-picture (PIP) mode or picture-by-picture (PBP) mode.

15. / / / and OK

-   : Press the  or  buttons to select settings.
-   : Press the  or  buttons to adjust OSD menu settings.
- Press OK to execute selections, or to enter a submenu you have selected.

16. / (Freeze)

Press this button to freeze the image on the screen (the signal will continue to be broadcast). Press the button again to unfreeze.

17. / (Screen aspect ratio)

Press this button to adjust screen image aspect ratio settings.

18. / (Sequential channel selection/Teletext page selection)

- Press these buttons to sequentially change channels.
- When the TV is off, press these buttons to turn it on and change channels.
- When Teletext is displayed on the screen, press these buttons to go to the previous or next page.

19. +/-

Press these buttons to raise or lower the volume level.

20. MENU

Press this button to display the OSD (On-Screen Display) menu for adjusting the image, sound and functions. Pressing this button again removes the OSD.

21. (Mute)

Press this button to mute the sound output. Press it again to restore the sound output.

22. Channel selection

- Press these buttons to select the channel you wish to view.
- When the TV is off, press a button to turn it on and go to the selected channel.

23. (Channel return)

Press this button to toggle between the current and the previous channel you were viewing.

24. Channel entry

Press this button before entering double-digit channels.

Using the Remote Control

When using the remote control, aim it at the remote control sensor window on the display. If there is an object between the remote control and the signal remote control sensor window on the display, the remote may not operate.

 **When using the remote control, please note:**

- **Do not strike or drop the remote. Do not expose the remote control to liquids and do not place it in humid environments.**
- **Do not install or place the remote control in direct sunlight. The heat may damage the remote control.**
- **If the remote control sensor window on the display is in direct sunlight or strong light, the remote control may not operate normally. In this situation, change the light source or readjust the angle of your display, or operate the remote control from a location closer to the remote control sensor window on the display.**

Batteries

You will need to install the supplied batteries into the remote control to make it operate following the instructions below.

1. Open the lid of the remote control battery compartment.

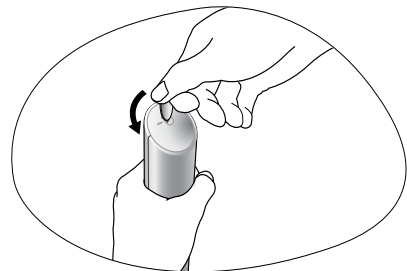

2. Insert two size-AAA batteries (included).

Ensure that the batteries are inserted with the positive and negative terminals in the correct direction corresponding to the (+) and (-) marks in the battery compartment.

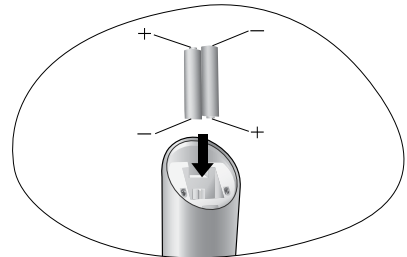

3. Install the lid of the remote control battery compartment.

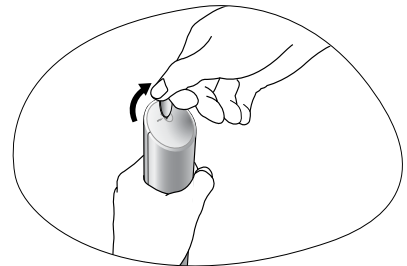

Notes on Using Batteries

The use of the wrong type of batteries may cause chemical leaks and/or explosion. Please note the following:

- Always ensure that the batteries are inserted with the positive and negative terminals in the correct direction as shown in the battery compartment.
- Different types of batteries have different characteristics. Do not mix different types.
- Do not mix old and new batteries. Mixing old and new batteries will shorten battery life and/or cause chemical leaks from the old batteries.
- When batteries fail to function, replace them immediately.
- Chemicals which leak from batteries may cause skin irritation. If any chemical matter seeps out of the batteries, wipe it up immediately using a dry cloth.
- Due to varying storage conditions, the battery life for the batteries included with your display may be shortened. If the remote control is not used for a long period of time, remove the batteries.

6 Using the Remote Control

Power on, Power off and Standby

Turning on the display

1. After plugging the display's power cord into a wall outlet, the display will turn on and enter standby mode automatically. The power indicator will light up red.
2. Press the **Power** button on the display, or press the  (**Power**) button on the remote control. The display will turn on. (The power indicator changes to green.)

Turning off the display

Press the **Power** button on the display, or the  (**Power**) button on the remote control again, and the display will go into standby mode. (The power indicator will turn red.)





Switching Inputs

1. Turn on all connected equipment or devices.
2. Press the **INPUT** button on your display, or press the  (**Input**) button on your remote control to display the current selected input.
3. Press the button repeatedly until your desired input is displayed. The sequence is as follows:
TV -> AV1 -> AV1-RGB -> AV2 -> AV2-S->AV3->AV3-S->AV4->AV4-S->Component 1-> Component 2->PC->DVI->TV...





 **AV3-S or AV4-S will appear only when the S-Video input of AV3 or AV4 is connected.**

Adjusting Volume

Adjusting the volume

1. Press the **Volume**  button on your display or press the  + button on your remote control to increase volume. The volume indicator will increase in length as volume rises.
2. Press the **Volume**  button on your display, or press the  - button on your remote control to decrease volume. The volume indicator will decrease in length as volume falls.

Mute setting

1. Press the  (**Mute**) button on your remote control to temporarily cut off the sound.
2. Press the  (**Mute**) button once more, or press the **Volume**  /  or **Power** button on your display to restore the sound level.



TV sound mode selection

Press the  (**TV sound mode selection**) button on your remote control to select "Sound 1", "Sound 2", "Sound 3", "Auto", "Nicom", "Stereo" or "Mono" systems (the items available will depend on the TV sound system being received).

Changing Channels

Change Channels Using the Channel selection buttons

- To select a single-digit channel, press the corresponding channel selection button on the remote control. For example, to select channel 8, press the  channel selection button on the remote control.
- To select a double-digit channel, press the Channel entry button on the remote control, and then enter the channel number using the channel selection buttons. For example, to select

channel 28, press the Channel entry button, and then the  ,  channel selection buttons on the remote control.

Using the Channel ▲ / ▼ buttons to sequentially change channels

Press the **Channel ▲** or **Channel ▼** buttons on your remote control, or press the **Channel ▲** or **Channel ▼** buttons on the display to sequentially select the TV channels available in your area.



Using the channel return button to return to the previous viewed channel



To return to the previous viewed channel, press the  (**Channel return**) button on your remote control.

Selecting a Picture Mode



To select a picture mode, press the  (**Picture mode**) button on the remote control. This enables you to select from the 6 preset memory settings. (Vivid, Standard, Movie, Sports, Personal 1 and Personal 2)

Using the Freeze Function



Press the  /  (**Freeze**) button on the remote control to freeze the image on the screen.

Press the  /  (**Freeze**) button again to restore normal motion.

Adjusting Aspect Ratio

Press the  /  (**Screen aspect ratio**) button on your remote control to select the image aspect ratio you prefer.

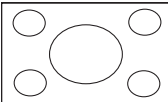
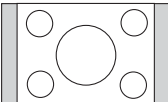
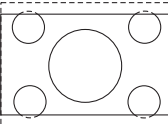
Press the button several times to cycle through various ratios.

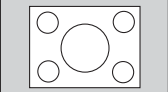
-  **Full Screen** - Enlarge the standard 4:3 video signal (e.g. TV signal) to 16:9 full screen video signal. When the original input video source is 16:9 in ratio (e.g. DVD signal), no change will occur.
-  **4:3** - Display the standard 4:3 video signal (e.g. TV signal) in the center of the screen at the ratio of 4:3. The screen does not change, but black blocks appears in the left and right sides of the screen. When the input video source is 16:9 in ratio, deformation will occur on the screen.
-  **Letterbox** - Fill the entire 4:3 screen with a 4:3 video signal. The redundant part on the upper and bottom of the image will be removed and the image will extend vertically and horizontally to fill the full screen. When the input video source is 16:9 in ratio (e.g. DVD signal), no change will occur.
-  **Anamorphic** - Fill the entire screen with a 4:3 video signal. Some deformations may be identified on the edge of the image. When the input video source is 16:9 in ratio (e.g. DVD signal), no change will occur.
-  **Real** - Display the actual size of the video source without zooming.

Using the Picture-in-Picture (PIP)/Picture-by-Picture (PBP) Function

If your display is connected to an additional Video or PC source, pressing the  **PIP/PBP** button allows you to display both images on the screen at once in PIP (Picture In Picture) or PBP (Picture By Picture) modes:

- **Full Screen:** Normal display.

- **PIP G on V:** Enter PIP mode and display graphics in video.
- **PIP V on G:** Enter PIP mode and display video in graphics.
- **PBP G by V:** Enter PBP mode and display graphics by video.
- **PBP V by G:** Enter PBP mode and display video by graphics.

☞ **V (video)= TV, AV1, AV1-RGB, AV2, AV2-S, AV3, AV3-S, AV4, AV4-S input image. G (Graphics)= Component 1, Component 2, PC or DVI input image.**

Using the Sleep Timer

1. Press the  (**Sleep timer**) button on your remote control to set the automatic sleep timer.
2. Press the button again to increase the time interval. Time is set in increments of 30 minutes, from 0 to 180 minutes.

Adjusting Backlight

To adjust the intensity of your display's backlight, press the  (**Backlight**) button on your remote control to select "Dark", "Normal" or "Bright".

When viewing the display in dimly lit rooms it is recommended to set the backlight to "Dark". Setting the backlight to "Dark" will reduce the image brightness and make the dark areas of the image darker thus maintaining a high contrast image in a dark environment.











Display Information

Press the  (**Information**) button on your remote control to display the signal information, including input video signal source, Video format, TV sound and current selected channel.

Using the Teletext Function

Press the  (**Teletext**) button on the remote control to enable the Teletext function. To disable the function, press the button again.

When Teletext is displayed on the screen, you can:

- Press the  (**Teletext display**) button to cycle Teletext display types among Teletext only - mixed display - TV video image only.
- Press the  (**Teletext index**) button to go to Teletext index page.
- Press the  (**Teletext information**) button to display some concealed Teletext information.
- Press the  (**Enter Teletext subpage**) button to enter the subpage of a Teletext menu.
- Press the , **I-II**,  or  buttons to jump to different pages.
- Press the   /   buttons to go to the previous or next page.

7 On-Screen Display (OSD) Menu

OSD Structure

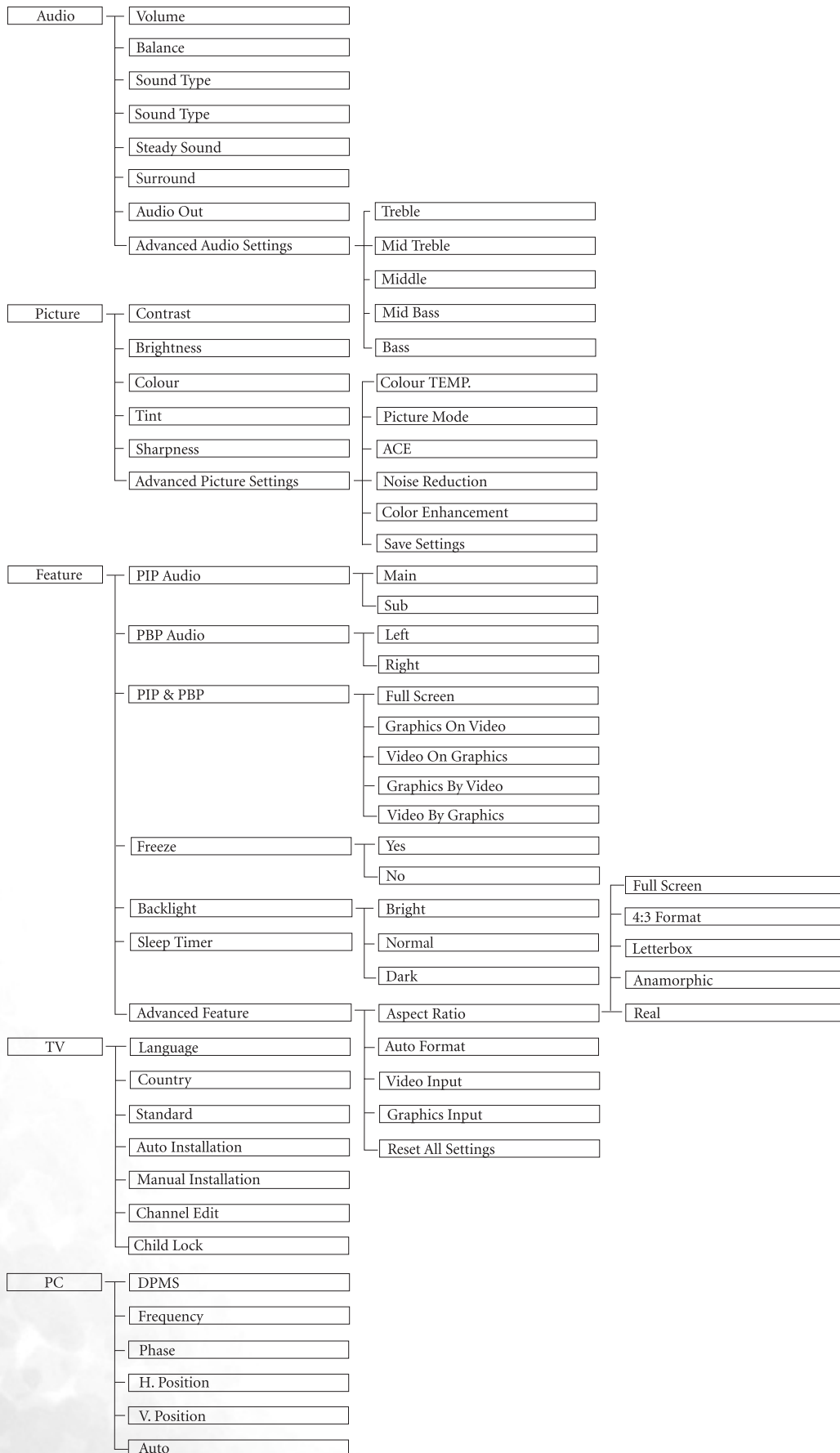

Navigating the OSD Menu

You can use the OSD menu screen to adjust all the settings on your display. Follow the steps outlined below to select the function you desire, and refer to the pages indicated for more information.



Press the **MENU** button on your remote control, or the **MENU** button on your display to bring up the following main OSD menu on the screen:



- Press the ◀, ▶, ▲ or ▼ buttons on the remote control, or the Channel ▲, Channel ▼, Volume ▶ or Volume ◀ buttons on the display to select items on the main menu, choose functions or change settings.
- Press the **OK** button on the remote control, or the **INPUT** button on the display to enter the submenu.
- Press the **MENU** button on the remote control, or the **MENU** button on your display to exit from the main menu.

☞ **For more information about the OSD menus, please refer to the following pages:**

- "Audio Menu" on page 19
- "Picture Menu" on page 21
- "Feature Menu" on page 23
- "TV Menu" on page 25
- "PC Menu" on page 28

Audio Menu

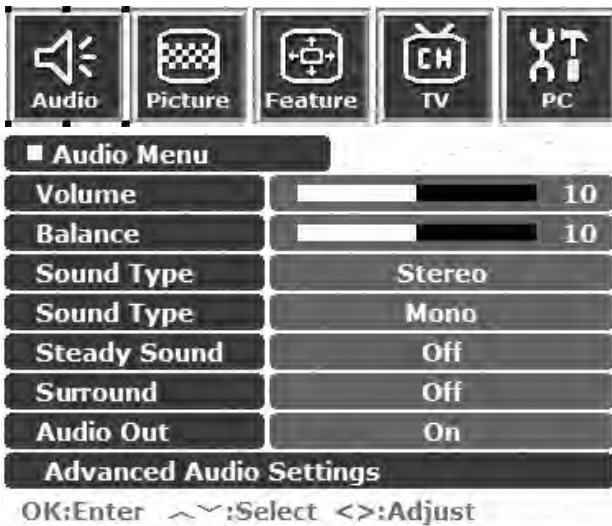

1. Press the **MENU** button on the remote control or the **MENU** button on the display to display the main menu.
2. Press the ◀ or ▶ buttons to select **Audio** and then press **OK** to enter the submenu.
3. Press the ▲ or ▼ buttons to select an item.
4. In the **Audio Menu**, use the ◀ or ▶ buttons to adjust the setting or select the options.
5. To return to the menu one level up, press the **MENU** button on the remote control, or the **MENU** button on the display.

Item	Function	Operation	Range
Volume	Adjust volume level.	Use ▶ to increase or ◀ to decrease volume.	0 to 47

Balance	Adjust left or right speaker volume level. ☞ This option will become unavailable if Audio Out is set to On.	Use ► to increase right speaker volume, ◀ to increase left speaker volume level.	-12 to +12
Sound Type	Select audio type (This option will only appear when AV1, AV1-RGB, AV2, AV2-S, AV3, AV3-S, AV4, AV4-S, PC, Component 1, Component 2 or DVI is selected as the signal source). ☞ This option will become unavailable if Audio Out is set to On.	Use the ► and ◀ buttons on the remote control or the Volume ► and Volume ◀ buttons on the display to change selection.	<ul style="list-style-type: none"> • Stereo • Sound 1 • Sound 2
Sound Type	Select TV audio (This option will only appear when TV is selected as the signal source).	Use the ► and ◀ buttons on the remote control or the Volume ► and Volume ◀ buttons on the display to change selection.	Auto, Mono, Stereo, Sound 1, Sound 2, Sound 3, NICAM
Steady Sound	Automatically adjusts the sound level to be constant amongst different TV stations when viewing TV programs. ☞ This option will become unavailable if Audio Out is set to On.	Use the ► and ◀ buttons on the remote control or the Volume ► and Volume ◀ buttons on the display to change selection.	<ul style="list-style-type: none"> • Off • Auto
Surround	Select a surround sound effect.	Use the ► and ◀ buttons on the remote control or the Volume ► and Volume ◀ buttons on the display to change selection.	<ul style="list-style-type: none"> • SRS TS • DOLBY Surround • Off
Audio Out	Select sound output from the internal speaker or external speaker.	Use the ► and ◀ buttons on the remote control or the Volume ► and Volume ◀ buttons on the display to change selection.	<ul style="list-style-type: none"> • Off • On
Advanced Audio Settings- Press OK to enter. ☞ This option will become unavailable if the Audio Out option is set to On or the Surround option is set to DOLBY Surround or SRS TS.			
Treble	Adjust treble tones	Use ► to increase treble tone, ◀ to decrease treble tone.	-12 to +12
Mid Treble	Adjust mid-treble tones	Use ► to increase mid treble tone, ◀ to decrease mid treble tone.	-12 to +12
Middle	Adjust mid tones	Use ► to increase middle tone, ◀ to decrease middle tone.	-12 to +12
Mid Bass	Adjust mid-bass tones	Use ► to increase mid bass tone, ◀ to decrease mid bass.	-12 to +12
Bass	Adjust bass tones	Use ► to increase bass tone, ◀ to decrease bass tone.	-12 to +12

Picture Menu

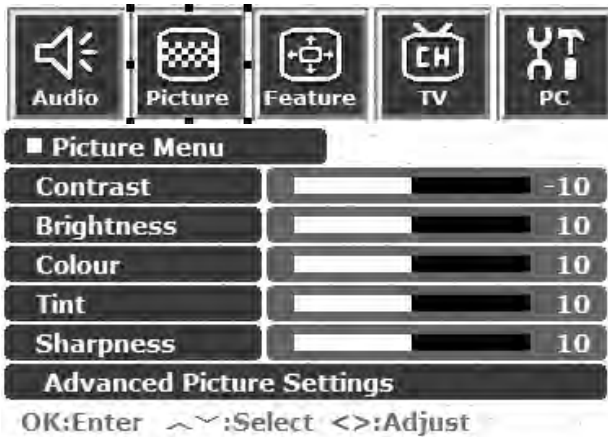

1. Press the **MENU** button on the remote control or the **MENU** button on the display to display the main menu.
2. Press the **◀** or **▶** buttons to select **Picture** and then press **OK** to enter the submenu.
3. Press the **▲** or **▼** buttons to select an item.
4. In the **Picture Menu**, use the **◀** or **▶** buttons to adjust the setting or select the options.
5. To return to the menu one level up, press the **MENU** button on the remote control, or the **MENU** button on the display.

Item	Function	Operation	Range
Contrast	Adjust image contrast.	Use ▶ to increase contrast, or ◀ to reduce it.	0 to 32
Brightness	Adjust image black level.	▶ for brighter blacks, ◀ for darker blacks.	0 to 60
Colour	Adjust colour saturation.	▶ for higher saturation, ◀ for lower saturation.	0 to 64
Tint	Adjust colour tint.	▶ for redder tones, ◀ for greener tones.	0 to 30
Sharpness	Adjust the sharpness level of the image.	▶ for a sharper image, ◀ for softer image.	-14 to 25
Advanced Picture Settings - Press OK to enter.			
Colour TEMP.	Adjust the color tint of the black and white part of the image.	Use the ▶ and ◀ buttons on the remote control or the Volume ▶ and Volume ◀ buttons on the display to change selection.	<ul style="list-style-type: none"> • Panel Default: Backlight color • Warm: Biased toward red • Normal: Standard video/TV color temperature • Cool: Biased toward blue - for PC input
Picture Mode	To restore a factory preset or user customized picture mode from memory.	Use the ▶ and ◀ buttons on the remote control or the Volume ▶ and Volume ◀ buttons on the display to change selection.	<ul style="list-style-type: none"> • Vivid • Standard • Movie • Sports • Personal 1 • Personal 2
ACE (Auto Contrast Enhancement)	Adjust the auto contrast enhancement function that optimizes the density of dark and bright areas of images.	Use the ▶ and ◀ buttons on the remote control or the Volume ▶ and Volume ◀ buttons on the display to change selection.	<ul style="list-style-type: none"> • Off • High • Middle • Low
Noise Reduction	Adjust the image noise reduction function that helps to remove noise in images.	Use the ▶ and ◀ buttons on the remote control or the Volume ▶ and Volume ◀ buttons on the display to change selection.	<ul style="list-style-type: none"> • Auto • High • Middle • Low
Color Enhancement - Press OK to enter.			
☞ This option will become unavailable if the ACE option is set to High, Middle or Low.			

Red	Adjust red in image.	▶ for more red concentration, ◀ for less red concentration.	0 to 30
Green	Adjust green in image.	▶ for more green concentration, ◀ for less green concentration.	0 to 30
Blue	Adjust blue in image.	▶ for more blue concentration, ◀ for less blue concentration.	0 to 30
Yellow	Adjust yellow in image.	▶ for more yellow concentration, ◀ for less yellow concentration.	0 to 30
Save Settings	Two different user profiles can be set.	Press ◀ or ▶ buttons to select the user situation preset Personal 1 or Personal 2. Then press OK to save your current settings.	<ul style="list-style-type: none"> • To Personal 1 • To Personal 2

Picture Mode Settings

1. Press the **MENU** button on your remote control or the **MENU** button on the display to display the OSD menu.
2. Press the ◀ or ▶ button to select **Picture** and press the **OK** button to enter the submenu.
3. Select an option (**Contrast, Brightness, Color, Tint...**) from the **Picture** menu to adjust your favorite image quality.
4. Press the ▲ or ▼ button to select **Advanced Picture Settings**, and press the **OK** button to enter the submenu.
5. Press the ▲ or ▼ button to select **Save Settings** and press the **OK** button.
6. Press the ▲ or ▼ button to select **To Personal 1** or **To Personal 2** and then press the **OK** button to confirm.

Selecting a Picture Mode

1. Press the **MENU** button on your remote control or the **MENU** button on the display to display the OSD menu.
2. Press the ◀ or ▶ button to select **Picture** and press the **OK** button to enter the submenu.
3. Press the ▲ or ▼ button to select **Advanced Picture Settings**, and press the **OK** button to enter the submenu.
4. Press the ▲ or ▼ button to select **Picture Mode**, and press the ◀ or ▶ button to select a picture mode you desire.
5. Press the **MENU** button to close the menu.

 You can also press the  (Picture mode) button on the remote control to switch to the picture mode you want directly.

Feature Menu

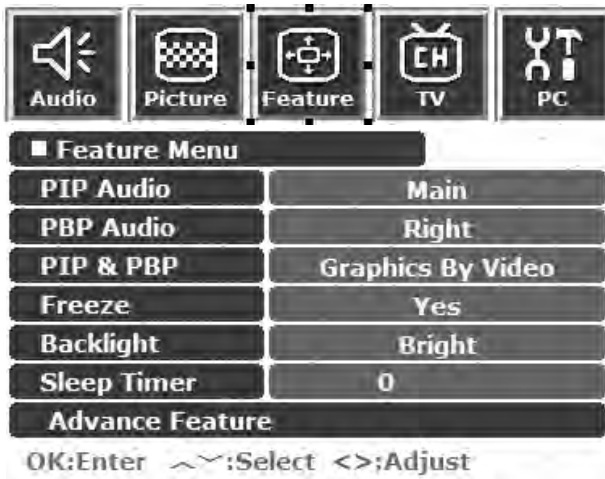

1. Press the **MENU** button on the remote control or the **MENU** button on the display to display the main menu.
2. Press the **◀** or **▶** buttons to select **Feature** and then press **OK** to enter the submenu.
3. Press the **▲** or **▼** buttons to select an item.
4. In the **Feature Menu**, use the **◀** or **▶** buttons to adjust the setting or select the options.
5. To return to the menu one level up, press the **MENU** button on the remote control, or the **MENU** button on the display.

Item	Function	Operation	Range
PIP Audio	Select which audio source you want to hear. ☞ This option is available only if the PIP mode is activated.	Use the ▶ and ◀ buttons on the remote control or the Volume ▶ and Volume ◀ buttons on the display to change selection.	<ul style="list-style-type: none"> • Main • Sub
PBP Audio	Select which audio source you want to hear. ☞ This option is available only if the PBP mode is activated.	Use the ▶ and ◀ buttons on the remote control or the Volume ▶ and Volume ◀ buttons on the display to change selection.	<ul style="list-style-type: none"> • Left • Right
PIP & PBP	Display video and images simultaneously in either Picture-In-Picture or Picture-By-Picture mode.	Use the ▶ and ◀ buttons on the remote control or the Volume ▶ and Volume ◀ buttons on the display to change selection.	<ul style="list-style-type: none"> • Full screen • Graphics On Video • Video On Graphics • Graphics By Video • Video By Graphics
Freeze	Freeze motion of screen image (however, broadcast continues).	Use the ▶ and ◀ buttons on the remote control or the Volume ▶ and Volume ◀ buttons on the display to change selection.	<ul style="list-style-type: none"> • No • Yes
Backlight	Adjust backlight intensity.	Use the ▶ and ◀ buttons on the remote control or the Volume ▶ and Volume ◀ buttons on the display to change selection.	<ul style="list-style-type: none"> • Dark • Normal • Bright
Sleep Timer	Set the Sleep timer to automatically turn off the display.	Use the ▶ and ◀ buttons on the remote control or the Volume ▶ and Volume ◀ buttons on the display to change selection.	0, 30, 60, 90, 120, 150, 180 minutes

Advanced Feature- Press **OK** to enter.

Aspect Ratio	Adjust image aspect ratio.	Use the ▶ and ◀ buttons on the remote control or the Volume ▶ and Volume ◀ buttons on the display to change selection.	<ul style="list-style-type: none"> • Full Screen - Enlarge the standard 4:3 video signal (e.g. TV signal) to 16:9 full screen video signal. When the original input video source is 16:9 in ratio (e.g. DVD signal), no change will occur. • 4:3 Format - Display the standard 4:3 video signal (e.g. TV signal) in the center of the screen at the ratio of 4:3. The screen does not change, but black blocks appears in the left and right sides of the screen. When the input video source is 16:9 in ratio, deformation will occur on the screen. • Letterbox - Fill the entire 4:3 screen with a 4:3 video signal. The redundant part on the upper and bottom of the image will be removed and the image will extend vertically and horizontally to fill the full screen. When the input video source is 16:9 in ratio (e.g. DVD signal), no change will occur. • Anamorphic - Fill the entire screen with a 4:3 video signal. Some deformations may be identified on the edge of the image. When the input video source is 16:9 in ratio (e.g. DVD signal), no change will occur. • Real - Display the actual size of the video source without zooming.
Auto Format	Set the display to automatically adjust screen aspect ratio when the SCART input is used.	Use the ▶ and ◀ buttons on the remote control or the Volume ▶ and Volume ◀ buttons on the display to change selection.	<ul style="list-style-type: none"> • Yes • No
Video Input	Select video signal input source for PIP/PBP function.	Use the ▶ and ◀ buttons on the remote control or the Volume ▶ and Volume ◀ buttons on the display to change selection.	TV, AV1, AV1 RGB, AV2, AV2-S, AV3, AV3-S, AV4, AV4-S
Graphics Input	Select graphics signal input source for PIP/PBP function.	Use the ▶ and ◀ buttons on the remote control or the Volume ▶ and Volume ◀ buttons on the display to change selection.	<ul style="list-style-type: none"> • PC • Component 1 • Component 2 • DVI
Reset All Settings	Restore all settings to default values.	Press the OK button on the remote control or the INPUT button on the display to reset.	

PIP/PBP Functions are available with 480P, 576P, 720P and 1080i HDTV formats.

TV Menu



OK:Enter ~:Select <>:Adjust

1. Press the **MENU** button on the remote control or the **MENU** button on the display to display the main menu.
2. Press the **◀** or **▶** buttons to select **TV** and then press **OK** to enter the submenu.
3. Press the **▲** or **▼** buttons to select an item.
4. In the **TV Menu**, use the **◀** or **▶** buttons to adjust the setting or select the options.
5. To return to the menu one level up, press the **MENU** button on the remote control, or the **MENU** button on the display.

Item	Function	Operation	Range
Language	Select language for the OSD menu.	Use the ▶ and ◀ buttons on the remote control or the Volume ▶ and Volume ◀ buttons on the display to change selection.	<ul style="list-style-type: none"> • English • Français • Nederlands • Deutsch • Italiano • Español
Country	Select your country where the TV is installed.	Use the ▶ and ◀ buttons on the remote control or the Volume ▶ and Volume ◀ buttons on the display to change selection.	<ul style="list-style-type: none"> • UK • France • Netherlands • Germany • Italy • Spain • Austria • Belgium • Luxemburg • Switzerland • Portugal • New Zealand • Australia • Others
Standard	Select the TV signal reception standard.	Use the ▶ and ◀ buttons on the remote control or the Volume ▶ and Volume ◀ buttons on the display to change selection.	<ul style="list-style-type: none"> • UK • FR • B/G/H • EURO • DK
Auto Installation	This function lets the TV tuner of your display search through all available channels and add them to memory.	Press the OK button to start auto installation.	
Manual Installation	Refer to "Performing Manual Installation" on page 26.		
Channel Edit	Refer to "Editing Channels" on page 26.		
Child Lock	Refer to "Child Lock" on page 27.		

Performing Manual Installation

The Manual Installation option allows you to manually adjust channel settings.

1. In the **TV Menu**, press the **▲** or **▼** buttons to select **Manual Installation**, and then press the **OK** button. The following Manual Installation menu will appear.



2. Press the **◀** or **▶** buttons to select a TV standard according to your local TV system.
3. Press the **▼** button to highlight **Select CH** and then press the **◀** or **▶** buttons to select a TV channel you want to set up.
4. Press the **▼** button to highlight **Frequency** and then press the **◀** or **▶** buttons to start the tuning system. If the tuned channel is incorrect, press the **◀** or **▶** button again until your desired channel is located.
5. Press the **▼** button to highlight **Fine Tune** and then press the **◀** or **▶** buttons to adjust the reception of TV signal.
6. (Optional) If the SCART signal input is connected, press the **▼** button to highlight **Decode** and then press the **◀** or **▶** buttons to select from the following options:
 - **On:** Select this option if you are using a decoder supplied from your TV system.
 - **Off:** Select this option if no external decoder is used.
7. Press the **▼** button to highlight **Text Code** and then press the **◀** or **▶** buttons to select a code format for the Teletext function.
8. Press the **▼** button to highlight **Store This Channel** and then press the **OK** button to save current channel settings to the memory.
9. Press the **MENU** button again to close the menus.

Editing Channels

You can delete unwanted channels, add a channel name and sort the received channels onto their correct channel numbers.

Naming a Channel

1. In the **TV Menu**, press the **▲** or **▼** buttons to select **Channel Edit** and then press the **OK** button. The following Channel Edit menu will appear.



2. Press the **▼** button, and then the **◀** or **▶** buttons to select the channel you wish to name.

3. Press the ▼ button to highlight **Edit Name** and then press the ◀ or ▶ buttons to enter a name for the channel.
4. Press the **MENU** button again to close the menus.

Swapping Channels

1. In the **TV Menu**, press the ▲ or ▼ buttons to select **Channel Edit** and then press the **OK** button.
2. In the Channel Edit menu that appears, press the ▼ button, and then the ◀ or ▶ buttons or the channel selection buttons to select the number of the channel you wish to change.
3. Press the ▼ button to highlight **PR Swap** and then press the ◀ or ▶ or the channel select buttons to select the channel to be moved.
4. Press the **MENU** button to close the menu. The channel will be moved on to the selected channel location.

Locking (Preventing a Channel from Selection)/Unlocking a Channel

1. In the **TV Menu**, press the ▲ or ▼ buttons to select **Channel Edit** and then press the **OK** button.
2. In the Channel Edit menu that appears, press the ▼ button, and then the ◀ or ▶ buttons or the channel selection buttons to select the number of the channel you wish to lock.
3. Press the ▼ button to highlight **Channel Lock** and then press the ◀ or ▶ buttons to select from the following options:
 - **Lock:** Lock selected channel.
 - **Unlock:** Unlock selected channel.
4. Press the **MENU** button to close the menus. If a channel is locked, it cannot be viewed if the Child Lock function (Refer to "Child Lock" on page 27) is enabled.

Deleting a Channel

1. In the **TV Menu**, press the ▲ or ▼ buttons to select **Channel Edit** and then press the **OK** button.
2. In the Channel Edit menu that appears, press the ▼ button, and then the ◀ or ▶ buttons or the channel selection buttons to select the number of the channel you wish to delete.
3. Press the ▼ button to highlight **Channel Delete** and then press the **OK** button to delete the channel.
4. Press the **MENU** button to close the menus.

Child Lock

The Child Lock function can be used for preventing children from viewing adult-only channels.

Enabling/Disabling Child Lock

1. In the **TV Menu**, press the ▲ or ▼ buttons to select **Child Lock** and then press the **OK** button. The following Child Lock menu will appear.

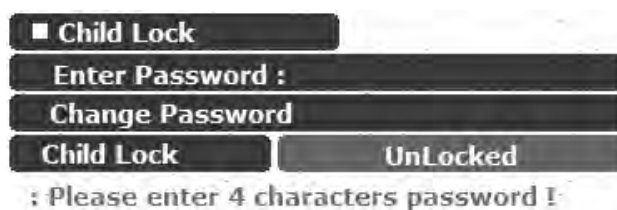

2. You will be prompted to enter the password (default password: 0000). Enter the password using the channel selection buttons. When entering, you can press the ◀ button to clear a wrong character.
3. Press the ▼ button to select **Child Lock** and then press the ◀ or ▶ buttons to select from the following options:

- **Locked:** Enable Child Lock. Once enabled, the locked channels (Refer to "Locking (Preventing a Channel from Selection)/Unlocking a Channel" on page 27 for how to lock a channel) will be locked.
 - **UnLocked:** Disable Child Lock.
4. Press the **MENU** button to close menus.

Changing Password

1. In the **TV Menu**, press the **▲** or **▼** buttons to select **Child Lock** and then press the **OK** button.
2. Press the **▼** button to select **Change Password** and then enter a new 4-digit password using the channel selection buttons.
3. Enter the new password again using the channel selection buttons.
4. Press the **MENU** button to close the menu.

PC Menu

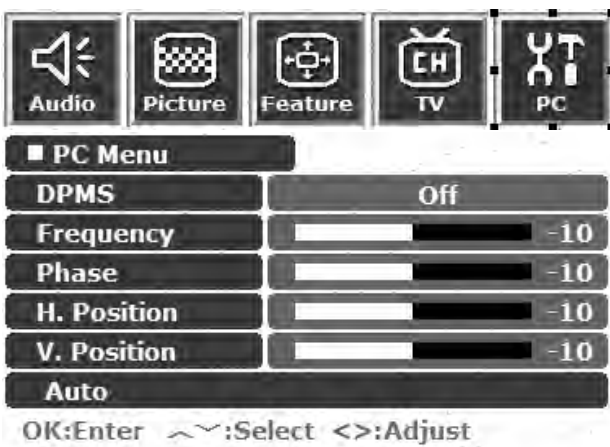



1. Press the **MENU** button on the remote control or the **MENU** button on the display to display the main menu.
2. Press the **◀** or **▶** buttons to select **PC** and then press **OK** to enter the submenu.
3. Press the **▲** or **▼** buttons to select an item.
4. In the **PC Menu**, use the **◀** or **▶** buttons to adjust the setting or select the options.
5. To return to the menu one level up, press the **MENU** button on the remote control, or the **MENU** button on the display.

Item	Function	Operation	Range
DPMS	Protect screen and enter power saver mode when no PC signal is detected.	Use the ▶ and ◀ buttons on the remote control or the Volume ▶ and Volume ◀ buttons on the display to change selection.	• Off • On
Frequency	Adjust display clock frequency.	Use the ▶ and ◀ buttons on the remote control or the Volume ▶ and Volume ◀ buttons on the display to change selection.	-15 to 15
Phase	Adjust display clock phase. When receiving Component video signal in 480P, 576P, 720P or 1080i format, you can use this function to enhance the sharpness of the picture.	Use the ▶ and ◀ buttons on the remote control or the Volume ▶ and Volume ◀ buttons on the display to change selection.	0 to 31
H. Position	Adjust horizontal position of the image.	Use the ▶ and ◀ buttons on the remote control or the Volume ▶ and Volume ◀ buttons on the display to change selection.	-30 to 30
V. Position	Adjust vertical position of the image.	Use the ▶ and ◀ buttons on the remote control or the Volume ▶ and Volume ◀ buttons on the display to change selection.	-30 to 30
Auto	Automatically adjusts frequency, phase, H. position and V. position to place the image on the screen.	Use the OK button on the remote control or the INPUT button on the display to begin auto adjustment.	

8 Troubleshooting

Before calling a service center, attempt the following steps to diagnose the problem.

TV

Symptoms	Possible Causes
Power does not turn ON	Ensure the power plug is securely inserted into the receptacle and wall socket.
There is no picture or sound	<ul style="list-style-type: none"> • Ensure the display power is ON (Indicated by the green Power indicator on the front of the unit) • Try a different input source to check whether the source is at fault. • Check for mis-connection of cables or for wrong input source.
There are spots on the screen	Your TV is being affected by interference from automobiles, trains, high-voltage transmission lines, neon signs or another sources of interference. Try redirecting or relocating your antenna to reduce the affects of the interference.
Degraded colours or tints	<ul style="list-style-type: none"> • Check whether all the picture adjustments have been properly performed. • Press the  (Picture mode) button on the remote control to select a different picture mode.
Improper screen position or size	Try selecting a different aspect ration by pressing the  /  (Screen aspect ratio) button on the remote control.
The image appears distorted	Ensure the display's aspect ratio is correctly set to suit the program source.
The image appears too bright, and there is a loss of definition in the brightest areas of the image.	<ul style="list-style-type: none"> • Reduce the contrast setting. • The DVD player is set for a high-level output. • The AV video signal has not been terminated properly somewhere in the external AV equipment.
The image appears too 'washed out', or the darkest areas of the image appear too bright.	<ul style="list-style-type: none"> • Reduce the brightness level till the black areas of the picture appear as black. • The DVD player may be set at too high a brightness level.
Power indicator lamp flashes red.	<ul style="list-style-type: none"> • Check the PC/DVI cable for disconnection. • This indicates the PC/DVI input has been selected with no PC/DVI source signal. • The TV has been placed in PC Standby mode.
"Out of range" appears	<ul style="list-style-type: none"> • Check whether the input signal is acceptable to the display.
Remote control does not function properly	<ul style="list-style-type: none"> • Check for incorrect battery orientation. • Check for dead batteries • Check your distance and angle from the display. • Check whether remote control is properly being pointed at the display's remote control sensor window. • Check for any obstacle between the remote control and the remote control sensor window. • Check that the remote control sensor window is not under strong fluorescent lighting. • Check for any devices (PC or personal digital assistant, PDA) nearby that transmit infrared signal which may cause interference to signal transmission between the remote control and the LCD display. Turn off the infrared function of these devices.

There is no picture or sound, just noise.	<ul style="list-style-type: none"> • Make sure the antenna cable is properly connected. • Change channels to confirm if the symptom is still present.
Picture is not clear.	<ul style="list-style-type: none"> • Make sure the antenna cable is properly connected. • Change channels to confirm if the symptom is still present. • If PC is selected as the input signal source, use the Auto function in the PC Menu to let the TV adjust picture automatically.
No sound.	<ul style="list-style-type: none"> • Check whether you have selected Mute for Audio setting. • Make sure the volume is not set to minimum. • Check the AV cables for disconnection.

Antenna

Symptoms	Possible Causes
The picture is not sharp or the picture moves contains image movement.	<ul style="list-style-type: none"> • The reception may be weak. • Change channels to confirm if the symptom is still present. • Make sure the outside antenna is not disconnected. • Make sure the antenna is facing the right direction.
The picture is doubled or tripled.	<ul style="list-style-type: none"> • Make sure the antenna is facing the right direction. • Picture ghosting is caused by reflections from buildings, large metal structures and mountains. Carefully realign your antenna to minimise the ghost images. Ultimately a higher quality antenna professionally installed may be necessary to reduce the ghosting.
The picture is spotted.	<ul style="list-style-type: none"> • There may be interference from automobiles, trains, high voltage lines, neon lights, etc. • There may be interference between the antenna cable and power cable. Try positioning them further apart.
There are stripes on the screen or colours fade.	<ul style="list-style-type: none"> • Is the display receiving interference from other devices? Transmission antennas of radio broadcasting stations and transmission antennas of amateur radios and cellular phones may also cause interference. • Use the display as far away as possible from devices that may cause possible interference.

Specifications

Model		DV3750
Size		94 cm (37 inches)
Aspect ratio		16:9
Resolution		1920 x 1080
Pitch		0.42675 x 0.42675 (mm)
Brightness		550 nits
Contrast ratio		800:1
Viewing angle		176°/176°
Response time		8 ms (Gray to Gray)
Amplifier		15W x 2
Signal inputs	TV	TV tuner
	Video	S-Video Composite video (RCA) Composite video (SCART) Component video (Y P _B P _R) Audio input
	PC	DVI PC D-sub DVI audio input PC audio
Signal outputs		SCART output Audio output Headphone output Subwoofer output
Scan format		480P/576P/720P/1080i
PC horizontal frequency		31.5 ~ 60 kHz
PC vertical frequency		50 ~ 70 Hz
Power supply		AC 100-240 V, 50-60 Hz
Operating temperature		0° C ~ 40° C (at sea level)
Storage temperature		-10° C ~ 50° C (at sea level)

 Design and specifications are subject to change without notice.

10 Supported Modes

Resolution	Horizontal Freq. (khz)	Vertical Freq. (Hz)	Bandwidth (Mhz)	Notes
720 × 400	31.47	70.08	28.32	DOS mode
640 × 480	31.47	60.00	25.18	DOS mode
640 × 480	37.50	75.00	31.50	VESA
640 × 480	37.86	72.80	31.50	VESA
800 × 600	37.88	60.32	40.00	VESA
800 × 600	46.86	75.00	49.50	VESA
1024 × 768	48.36	60.00	65.00	VESA

 Optimal settings for this product are as listed above. It is suggested that you select appropriate settings from this table to obtain optimal performance.

11 Dimensional Drawings

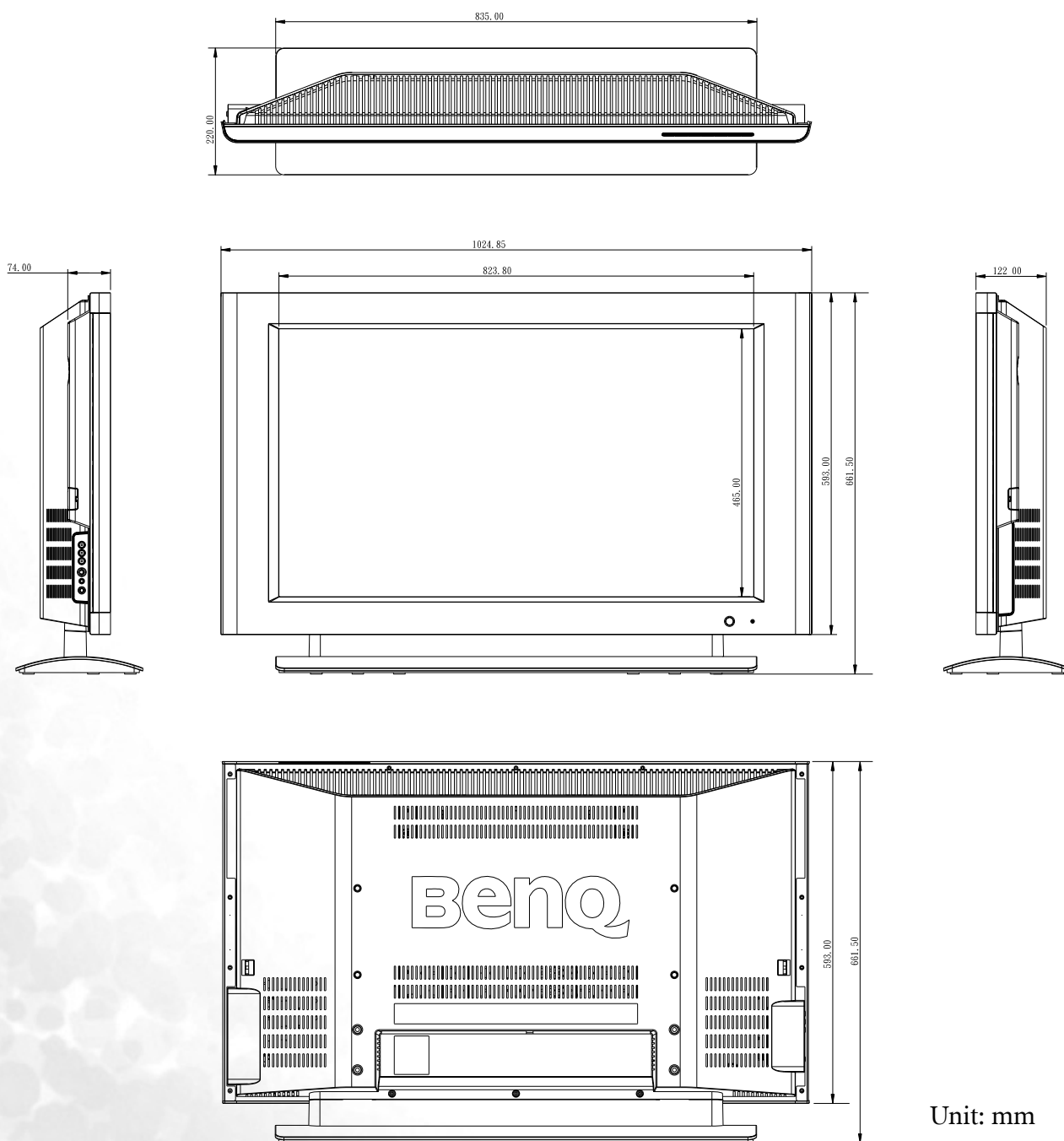

Unit: mm